

EN

Original operating manual
Multi-Signal

97800D EN - 08/2023



Multi-Signal

Quartz / cable / radio /
incl. INTERSECTION+

Type 2643111C
2643111CR



horizont

horizont group gmbh
Traffic Safety

P0 Box 13 40
34483 Korbach, Germany

Homberger Weg 4-6
34497 Korbach, Germany
Germany

Phone: +49 (0) 56 31 / 5 65 - 2 00
Fax: +49 (0) 56 31 / 5 65 - 2 48

traffic@horizont.com
www.horizont.com



Contents

1.	General safety instructions.....	3
2.	Multi-Signal	8
2.1	Micro-Terminal.....	9
2.2	Main menu functions.....	10
2.3	Signal head.....	11
2.4	Assigning connection type, radio channel and traffic light number	11
3.	Setting up and putting a system into operation	13
3.1	Quartz system	13
3.2	Cable-linked system.....	13
3.3	Radio-linked system.....	14
3.3.1	Normal operation.....	14
3.3.2	Selecting the radio channel.....	14
3.3.3	Quartz fall-back mode.....	15
4.	Programming.....	16
4.1	Status display on the operating terminal.....	16
4.2	Programming construction site signalling systems.....	16
4.2.1	Functionality and parameters.....	16
4.2.2	Standard systems	19
4.2.2.1	One way	20
4.2.2.2	Junction.....	20
4.2.2.3	Exit.....	21
4.2.2.4	4way 1lane	21
4.2.2.5	2-way intersection.....	22
4.2.3	Spezial.....	22
4.3.	Programming intersection systems, INTERSECTION+	22
4.3.1	Functionality and parameters.....	22
4.3.2	Examples.....	26
4.3.2.1	Pedestrian crossing with demand unit.....	26
4.3.2.2	Bottleneck with pedestrian crossing.....	27
4.3.3	Programming form	28
4.4	Setting the time	28
4.5	Extended program options.....	28
4.6	SVS radio remote switch.....	29
4.6.1	Operating terminal.....	29
5.	Using the program memory	29
6.	Status messages and error display	30
7.	Securing the signals	30
8.	Red time counter (RTC).....	30
8.1	Cabling	31
8.2	Terminal assignment.....	31
9.	Changing the battery and putting a system into operation.....	32
9.1	Changing the battery.....	32
9.2	Fuse.....	35
10.	Technical parameters	35
10.1	Classifications	35
11.	Spare parts overview.....	37
12.	Accessories	38

1. General safety instructions

The unit must be switched off before any intervention!

Information on the operating instructions

The operating instructions provide important information on how to use the unit. All technical information in the manual has been compiled with the utmost care. Nevertheless, errors cannot be excluded. We would like to point out that neither guarantee, nor any legal responsibility, nor any liability for consequences, consequences resulting from incorrect information. We are grateful at any time errors at any time. A prerequisite for safe working is compliance with the specified safety instructions and handling instructions.

In addition, the local accident prevention regulations and general safety regulations in force and general safety regulations applicable at the place of use of the unit. The operating instructions must be read carefully before starting any work! They are an integral part of the product and must be kept in the immediate vicinity of the unit, accessible to the personnel at all times.

If you sell or pass on this product, be sure to hand over this manual as well hand out this manual. The illustrations in this manual are not necessarily to scale in order to better illustrations and may differ slightly from the actual slightly from the actual design.

Meaning of pictograms

Safety notes are characterised by pictograms.

Additionally they are precluded by signal words, expressing the scale of the hazard.

- Safety Instructions must be duly observed under all circumstances!
- Always act cautiously in order to avoid accidents, personal injuries and damage to property!

Warning!



Indicates a potentially dangerous situation which can result in death or severe injuries if not being avoided.

Caution!



Indicates a potentially dangerous situation, which may lead to minor or light injuries if not being avoided.

Caution!



Indicates a potentially hazardous situation that may result in property damage if not being avoided

Hints and recommendations

NOTE!



Highlights useful hints and recommendations as well as information for an efficient and trouble-free operation.

Limitation of liability

All information and instructions in this manual were compiled under consideration of all valid and applicable standards and regulations, our state of the art technique as well as our long-term experience and knowledge.

The manufacturer assumes no liability for damage due to:

- Non-observance of the operation and maintenance instructions
- Improper / unintended use
- Deployment of non-trained personnel
- Unauthorized conversions
- Technical changes
- Use of non – approved / unauthorized spare and wear parts

In case of ordering customized versions, use of additional options or due to state of the art technical alterations the actual scope of supply may differ from the explanations and illustrations described in this manual.

Additionally the responsibilities agreed upon in the delivery contract, the general terms and conditions as well as the manufacturer's conditions of delivery and the statutory provisions valid at the time of contract conclusion shall apply.

Warranty

Wear parts are all components having direct contact with the material processed by the machine. These components are excluded from warranty and defect claims provided it is wear.

Warranty

The manufacturer guarantees the functional capability of the process technology used and the stated performance parameters. The warranty period begins at the time of acceptance without defects.

Warranty

The individual warranty conditions can be found in the sales contract.

In general rules:

In case of conversions or technical modifications which were not certified by horizont group gmbh, any warranty claims expire.

Repairs to the towing device of the vehicle may only be carried out by certified workshops or the manufacturer itself.

Spare Parts

Warning!



Incorrect or faulty replacement parts may lead to damages, malfunctions or even total breakdown of the device, thus severely affecting the safety.

Always use original spare parts only!

Original spare parts can be obtained directly from the manufacturer.

Customer service

In case you need any technical information or advise, our customer service is at your disposal. Furthermore our employees always appreciate receiving feedback from the user - such as experiences arising during the application - in order to constantly work on improving our products.

Copyright

This manual is intended exclusively for persons working with the unit. This manual may not be passed on to third parties without the written consent of the manufacturer.

In case you need any technical information or advise, our customer service is at your disposal. Furthermore our employees always appreciate receiving feedback from the user - such as experiences arising during the application - in order to constantly work on improving our products.

NOTE!



Any content of this instruction like texts, drawings, pictures and other representations are protected by copyright law and subject to industrial property rights. Any improper use is punishable. Reproduction in any form - even in extracts - as well as the utilization and / or communication of the contents are not permitted without written consent of the manufacturer. Violations require compensation. Further claims remain reserved.

Safety

This section gives an overview of all important safety aspects for optimum protection of personnel and for a safe and trouble-free operation. Failure to comply with the safety instructions stated in this manual may lead to considerably hazardous situation.

Responsibility of the operator

The operator of the device is subject to the legal obligations for safety at work.

In addition to the safety instructions in this manual the safety standards, accident prevention as well as environment protection regulations on site have to be adhered to.

It is essential that the operator

- is informed about the applicable health and safety regulations on site.
- identifies additional hazards which might arise due to special working conditions at the operation site by means of a risk assessment.
- implements the necessary rules of conduct stated in the user manual at the operation site.
- check at regular intervals during the machine's entire period of use whether the user instructions correspond to the current state of rules.
- clearly regulates the responsibilities for installing, operating, maintaining and cleaning the device.
- ensures that all employees working on or with the machine have read and understood the operating instructions. In addition he must at regular intervals train the employees in how to deal with the machine and inform them about potential hazards.

In addition, it is the operator's responsibility to ensure that:

- the machine is always in a technically perfect condition.
- the machine is maintained in accordance with specified maintenance intervals.
- all safety equipment is regularly checked for completeness and correct functioning.
- the required inspections are carried out or arranged to be carried out at a self-defined or predefined time interval.

Staff requirements

Qualification

WARNING!



Inappropriate handling can lead to considerable personal injury and property damage. All activities should only be carried out by qualified personnel.

Hazards

The following section lists residual risks that were determined on the basis of a hazard analysis.

The hazard notes listed here and the safety instructions in the previous sections of this manual must strictly be observed to reduce possible health hazards and to avoid dangerous situations.

Electrical current

DANGER!



Touching live parts is an immediate risk of fatal injury. Damage to the insulation or individual components can be potentially life-threatening.

Repairs to the electrical system of the device may only be carried out by qualified electricians!

Before carrying out any work on the device, first disconnect the negative terminal and then the positive terminal on the rechargeable batteries.

Akkus und Batterien

WARNING



Improper handling of batteries or rechargeable batteries may release toxic substances or even lead to their explosion.

During the charging process, explosive gas mixtures can originate. Therefore

- **you may not** smoke
- **you must avoid** sparking and ensure adequate ventilation
- **you may not** use any flammable cleaning agents in the immediate vicinity of the batteries !

Heed the instructions of your manufacturer for rechargeable batteries!

Environmental protection



CAUTION!

Rechargeable batteries contain toxic heavy metals. They are hazardous waste and must be collected and disposed of in accordance with the local applicable regulations. It is the owner's responsibility to inform about disposal regulations and disposal centres.

Intended use of the product

WARNING!



Any use of the device beyond its intended use or any other use not in accordance with the instructions may lead to dangerous situations for which **horizont group gmbh** does not assume any responsibility.

For this reason:

- you may only use the device for its intended purpose.
- you have to strictly follow all instructions in this manual. In particular, refrain from the following operations, which are deemed to be improper: modification, conversion or alteration of the construction or individual equipment parts with the aim of altering the usability of the device.

Claims of any kind for damage resulting from improper use are excluded. The operator alone is liable for all damage resulting from improper use.

2. Multi-Signal

The Multi-Signal 2.0 signalling system is a modern portable traffic light system for controlling traffic at construction sites and simple intersections. It can be operated in radio, cable or quartz fall-back mode.

When operated in radio mode, the 6 frequencies permitted in Germany are available for use (frequencies for other countries on request). In the event of radio interference, the frequencies can be changed manually. Robust NATO telephone cable is used to establish the cable connection.

Depending on the application, up to 8 fully identical signal heads can easily be combined to form bottleneck, junction or simple intersection systems (also with pedestrian crossings and special signals).

In order to flexibly adapt the system to suit different traffic situations, 5 different programs can be activated for each system, depending on the time and weekday. The operating modes “flashing”, “red” and “lamps off” are also available.

Using radar sensors, pedestrian push buttons (with feedback), etc., traffic-dependent extension of – or request for – green time can be achieved. The interval, extension time, minimum green time and priority can be defined separately for each group.

In order to synchronise the system with stationary systems, it offers the most frequently used recalculation methods for the purpose of time synchronisation or evaluating synchronous pulses.

Manual switching is carried out via an optionally available radio remote control.

The system is programmed using the simple and intuitive Micro-Terminal. Pre-installed programs for bottlenecks, junctions and intersections limit the required inputs for all standard applications to just a few parameters. An integrated calculation program automatically determines RiLSA-compliant times from the construction site length and clearance speed (bottlenecks & junctions only). (RiLSA = Richtlinien für Lichtsignalanlagen/German Guidelines for Traffic Signals). Error and status messages are output in full text format.

The terminal can be removed once programming has been completed. This protects the system against unauthorised intervention.

The Multi-Signal is manufactured to the highest quality standards and complies with the European standards DIN EN 12368 (Traffic control equipment - Signal heads) and DIN EN 12675 (Traffic signal controllers).

When linked by cable, properly installed systems correspond to type D according to the “Technical Delivery Conditions Portable Traffic Light Systems 97”.

Radio-controlled systems correspond to type B or C and quartz-controlled systems to type A.

The operation of radio transmission equipment must be registered with the Federal Network Agency in Germany. Please note - especially when changing existing registrations - that one 6-frequency transmitter/receiver unit must be registered for each signal head.

Registration is subject to a fee. Responsible branch offices and registration forms can be found on the internet at www.bundesnetzagentur.de, keyword “nöml” (non-public land mobile radio).









The radio transmission equipment version must be correspondingly approved for use in the respective country (see point 9).

2.1 Micro-Terminal



The system is operated via 12 keys which offer the following basic functions:

-  Select a menu item or confirm an entered value on the primary display: Select the operating mode
-  Increase an input value/select the input “Yes”
-  Decrease an input value/select the input “No”
-  Cancel the current input and return to the beginning of a sub-item or an input loop.
On the primary display: Open the info display, press again to invoke the radio channel selection function.
-  Scroll the display or jump to the previous line. Switch between the signal heads on the main display. The selected signal head is marked with an underscore
-  Scroll the display or jump to the next line. Switch between the signal heads on the main display. The selected signal head is marked with an underscore
-  Load the program from the program memory and send it to the controller



Open the bottleneck program for faster system set-up



Open the junction program for faster system set-up



Open the error memory (log book)



Delete/reset error



Open the main menu for various programming and advanced settings

All entries and changes (with the exception of changing the operating mode) are initially only stored in the terminal. Only when a new program is transferred do the new values also become effective in the system.

The various settings and programming options are described below.

2.2 Main menu functions

• Brief description of the individual functions:

- Programming
- Editing program
- Download program
- Upload program
- Deleting program
- Set the clock
- Configure radio
- Options

Programming:

Various programming modes are stored under this menu item

- Oneway (2 signal heads)
- 3 Phase 1 Lane (3 signal heads)
- Exit (3 signal heads)
- 4way 1lane (4 signal head groups)
- 2way intersect (2 signal head groups)
- Pilot (1 signal head with manual changeover function)
- Special
- INTERSECTION+

• **Editing program:**

Programs stored (in the controller) can be edited here.

• **Download program:**

Load current program from the signal head to a controller.

- **Upload program:**

Load or transfer a program stored in the controller to the signal head.

- **Delete program:**

Delete a program stored in the controller from the memory.

- **Set the clock:**

Setting the correct time is essential for the signal head to function correctly, because the time is transferred to the signal head during programming and is therefore of particular relevance when using different switchover times.

- **Configure Radio:**

Set and change the radio channel

- **Options:**

The basic settings of the signal head are entered here. These include the country variant (different signal patterns), language, system dimming at night, quartz fall-back mode and other settings.

The signal head is preset for use in Germany, see point 3.5.

The setting must be adjusted accordingly if the signal head is used in other countries!

2.3 Signal head

The signal head comprises three chambers for the red, amber and green signal lamps and a half chamber at the top which houses the radar sensor. The signal heads are fitted with LED optics.

The antenna is mounted above the upper chamber. For transport, the antenna should be removed from the antenna base and refitted using the screw provided on the antenna plate.

A 6-pin socket (CA6) is fitted in the lower chamber. The operating terminal is connected to this socket.

The electronics and main fuse are located inside the lower “green” chamber and the radio modem is housed inside the middle “amber” chamber.

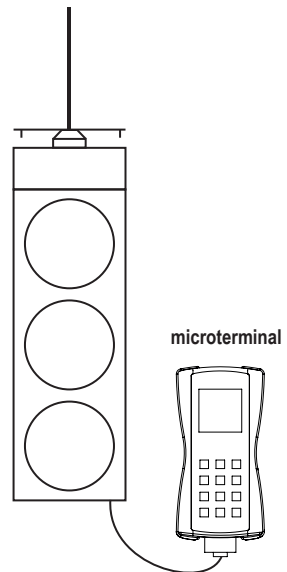

2.4 Assigning connection type, radio channel and traffic light number

Before putting into operation: The individual signal heads are assigned their positions and task within a system using a “traffic light number”. This number allows them to be iden-

tified in the network and this is the only way for them to receive the program parameters and commands necessary for their task. Traffic light numbers must be assigned consecutively in ascending order, starting with “1”.

For the system to function properly, it is also necessary to set radio, cable or quartz mode.

Proceed as follows to put into operation:

- Disconnect the respective signal head from the power supply (also disconnect the cable in cable-linked systems).
- Plug in the controller.
- Reconnect the power supply.

New system ? yes

- The following prompt appears on the display: “New system?” Use the “+” key to select the answer “yes” and confirm your entry.

If the system was put into operation at an earlier time and the number of signal heads remains unchanged, use the “-” key to select the answer “no” and confirm the entry with “E”. You can then start editing the program directly or load a saved program.

The current settings are displayed. The arrow points to the value to be changed.

Connection:	radio
Radio channel:	1
Amount of contr.:	2
Controller:	1

- Connection** Type of connection to be used
- Radio channel** Radio channel (radio frequency) on which the signal head is to operate. The radio channel can also be changed during operation (see point 2.3.2).
- Head number** Identification number (traffic light number) of the signal head within a system

Number of signal heads:

Defines the number of signal heads within the system. The number is needed to correctly display the signal heads if a program has not yet been loaded onto the system. Where required, it will be overwritten by the program.

A program that is still active is automatically deleted. The last signal aspect assignment (see point 3.2.1) is retained.

The values for **connection, traffic light and radio channel** are retained (even when the power supply is switched off or the system is reprogrammed) until they are reset. Quartz programs are an exception, because they overwrite the traffic light number.

3. Setting up and putting a system into operation

3.1 Quartz system

Quartz systems can be set up extremely quickly and reliably.

Since there is no connection between the individual signal heads, they are not capable of vehicle actuation and also do not have the signal safeguarding function. They are therefore only suitable for use in type A systems.

- Set all of the signal heads to quartz mode (see point 1.3).
- Position the signal heads in accordance with the technical traffic documentation and cover the signal heads or turn them to face away from traffic.
- Now start at the signal head that is to be assigned number 1. Connect the power supply and plug in the operating terminal. Check (correct if necessary) the time and enter the program as set forth in point 3.
- Once programming has been completed, answer the question “Is this traffic light 1” with “yes” and then confirm the entry with “E”. The traffic light number of the signal head to which the terminal is connected is now set to 1 and all required program values are transferred.

You will then be prompted to go to traffic light 2. Once there, connect the “power supply”, plug in the terminal and transfer the program.

- Continue transferring the program for all of the other signal heads in the same manner.
- Remove the covers or turn the signal heads to face the traffic at a suitable moment.

3.2 Cable-linked system

Setting up a cable-linked system is costly because it is necessary to lay the cables.

However, such a system is not susceptible to radio interference – even if it is in use for a long period – and is therefore also suitable for type D systems according to the “Technical Delivery Conditions Portable Traffic Light Systems 97”.

- Set the signal heads to cable operation, the traffic light number and, if necessary, the number of signal heads in the system in accordance with the technical traffic documentation (see point 1.3).
- Place the signal heads at their designated locations in accordance with their number and connect the connecting cables. The order of cabling has no influence on the program sequence.
- Cover the signal heads or turn them to face away from traffic. Connect the power supply.
- Plug the operating terminal into one of the signal heads, enter the program as set forth in point 3 and transfer it to the system. The program is stored in the number 1 signal head and distributed from there to the other signal heads.
- Following a check to ensure the program is running correctly, switch the system to “flashing” or “off” mode, remove the covers and then switch back to “automatic”.

3.3 Radio-linked system

3.3.1 Normal operation

Radio systems can be set up just as quickly and easily as quartz systems. However, they also offer the option of running vehicle-actuated programs and have secured signals, also making them suitable for use in type B and type C systems.

- Set the signal heads to radio-linked mode, enter the head number and, if necessary, the number of signal heads in the system in accordance with the technical traffic documentation (see point 1.3).
- In the case of multi-frequency systems, the same radio channel or automatic frequency selection must be set on all signal heads (see points 2.3.2 and 1.3). If several independent multi-signal systems are operated within a radius of approx. 2 km (radio range), each radio system must operate on a different (discrete) radio frequency. In this case, we recommend that one of the 6 available frequencies is manually assigned. Should you still wish to use automatic frequency selection for initial setup, ensure that the “auto” setting is not used. This will prevent frequencies from being changed automatically e.g. in the event of a poor connection.
- Place the signal heads at their designated locations in accordance with their number.
- Cover the signal heads or turn them to face away from traffic. Connect the power supply.
- Plug the operating terminal into one of the signal heads, enter the program as set forth in point 3 and transfer it to the system.
The program is stored in the number 1 signal head and distributed from there to the other signal heads.
- Following a check to ensure the program is running correctly, switch the system to “flashing” or “off” mode, remove the covers and then switch back to “automatic”.
- Please note that if the signal heads are placed too close together (approx. 1-15 metres) (e.g. when setting them up), the radio link may experience interference due to crosstalk. In this case, separate the signal heads so they are a little further apart.

3.3.2 Selecting the radio channel

In order for the signal heads to establish a radio connection with each other, they must all operate on the same frequency or radio channel. The radio channel is set on each individual signal head at the same time as the head number is set (see point 1.3) – or during operation using the terminal.

Plug the terminal into the system during operation. As soon as the status display appears (see point 3.1), press the “R” key twice to open the frequency menu. The following information is displayed there:

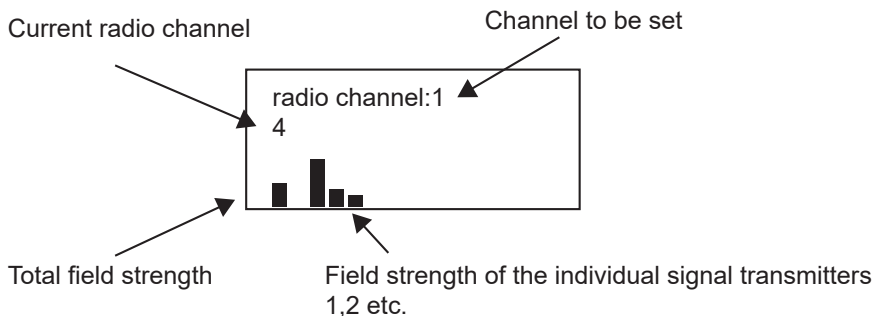

Now select the desired channel using the “+” and “-” keys and confirm it with “E”. To ensure that all signal heads are operating on the same frequency, this procedure must be repeated at each signal head.

The following settings are possible:

- auto** Automatic selection of a suitable frequency from the available frequencies (see point 9). If radio interference occurs, another frequency is automatically scanned for. The current radio channel is indicated on the controller by “A:<current channel>”. E.g.: A:1
- 1, 2, ..** Radio channel 1, 2, etc.
The assignment of the frequencies to the radio channels can be found in the technical parameters (see point 9).

! CAUTION!

In environments with heavy interference, especially when several systems are operating within radio range, the frequency selection may fail during operation.

3.3.3 Quartz fall-back mode

Radio-linked systems continue to operate in quartz fall-back mode in the event of a radio link failure. In this case, each signal head is controlled by its internal quartz timer. Instead of green, the signal head now displays a flashing amber light. Vehicle-actuated programs display the minimum green time plus half the “flashing amber” extension time. This allows signalling to be provisionally maintained until the radio connection can be re-established. So that the system does not constantly switch back and fore between quartz fall-back mode and normal operation in the event of a poor radio connection, quartz fall-back mode remains active for at least 3 cycles, even if the radio connection has already been properly re-established.

Quartz fall-back mode can be activated and deactivated via the menu item “OPTIONS”. If the parameter “Timeout” = 7.5 s is selected, the system also displays “Green” as the green signal in quartz fall-back mode. (See point. 3.5).

4. Programming

4.1 Status display on the operating terminal

Once the operating terminal has been plugged in the status appears on the display:

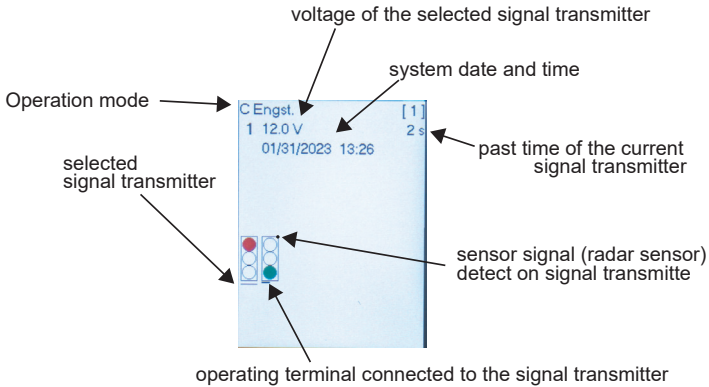

The wide cursor (underscore) indicates the signal head for which the battery voltage and any errors are displayed. Use the up and down arrow keys to switch to the next signal head.

The small square to the right of the “Red” signal on the signal head display indicates that the sensor (radar) on the respective signal head is delivering a signal.

The buttons perform the following functions:



Transition to operating mode selection. Possible modes are “Automatic”, “Manual”, “Amber flashing”, “Lamps off”, “Red” and the “Stop” command.



Transition to the programming menu



Transition to the information window and frequency menu (see point 2.3.2).

4.2 Programming construction site signalling systems

4.2.1 Functionality and parameters

The programs for construction site signalling systems consecutively assign all groups “green” (“coffee grinder”), taking the intergreen period (red/amber+red+amber) into consideration.

Vehicle actuation is determined by the following parameters per group:

Traffic gap	Time in seconds after which the extension time is cancelled if the sensor no longer detects any vehicles.
Minimum green	Green time in seconds that is set even without a sensor signal (sometimes called “minimum initial”).
Extension time	Maximum additional green time that is additionally set after the minimum green time has expired if there is a sensor signal.
Hold on red	The corresponding group holds in the “Red” position until the associated sensor delivers a signal.
Priority	If the corresponding sensor delivers a signal, the extension times of the other groups are interrupted so that the group receives “green” as a priority.

A maximum of 5 programs can be created for each system, which can be switched on at a maximum of 20 different times on any days of the week.

The switchover times set the weekdays, the time of day and the program to be activated (or "Flashing (Fl) or "Off").

The following parameters are available for programming:

Amount of groups 3

Number of signal groups in the system. Maximum 7

group 1 C1 Type: Standard
--

Type of signal heads in the group (see below).

group 1 C1 controllers 2

Number of signal heads in the group. A maximum of 8 signal heads can be distributed among the required groups.

group 1 C1 Traffic gap: 4,0s

Interval in seconds

group 1 C1 Red / Yel. 1s

Red/amber - Time in seconds

group 1 C1 Yellow 4s

Amber - Time in seconds

„All Red Times“ Distance C1 → C2 100m
--

Distance between the stop lines of the respective signal heads

„All Red Times“ Speed C1 → C2 30 km/h
--

Speed with which the vehicles drive from the direction of the group Kx through the construction site towards Ky.

„All Red Times“ All Red C1 → C2 5s

Red time required to pass through the construction site from Kx towards Ky.

Amount of programmes 1

Number of programs used (max. 5)

Program 1 C1 green → 5s
--

Minimum green time

Program 1	C1
Extension:	10s

Maximum additional green time if there is a sensor signal. If no sensors are used, the minimum green time must be increased by this value and the extension time must be set to 0.

group 1	C1
Rest Red:	No

If "yes" then wait position red

group 1	C1
Priority:	No

If "yes", the group is assigned priority green

Amount of switching times	
1	

Number of switchover times (max. 20) If no switchover time is used (0), program 1 always runs.

Switch Time 1	
Days: MTWTTSS	
Program: Program 1	

To define a switchover time, the weekdays on which it is valid, the time in hours:minutes and the program that is to be activated at this time are entered.

In addition to entering the program number, "Fl" (flashing) and "Off" (lamps off) are possible.

Parameter	
Max red:	--s

Maximum red time. Groups waiting in the "Hold on red" position are set to green once the maximum red time has expired, even if there is no sensor signal.

Parameter	
Min green:	10s

Minimum green time.

Parameter	
Min red:	1s

Minimum red time. Used when regressing back to the same phase.

ONEWAY	
oneway (Program name)	

Overview of the created program, program name and the number of programs.

Using the clearance speed and distance between the signal heads as the basis, the controller determines the RiLSA-compliant red times for the individual signal groups (for bottlenecks and junctions only). Furthermore, optimal minimum green and extension times are determined, assuming a traffic volume of 900 vehicles/hour, which is evenly distrib-

uted over all approaches. The calculation is always performed whenever other values for clearance speed or distance are entered. The calculated values can then be overwritten if necessary.

Signal head types:

Standard	signal head having the signal sequence “red-red/amber-green-amber-red”. In operating mode “flashing” it flashes amber.
Main	signal head having the signal sequence “red-red/amber-green-amber-red”. In operating mode “flashing” it remains off.
Pedest.	signal head having the signal sequence “red-green-red”. When demanded, amber is switched on and can be used as “signal coming”.
Flash yellow	signal head having the signal sequence “red-amber flashing amber-red”.
Flash Yel.3	signal head having the signal sequence “Red-red/flashing amber in the 3 rd chamber amber-red”

A selected signal head type can only be changed by overwriting it with a new program or by a “Stop” command (see point 3.1). The “Stop” command sets the signal head type to “Standard.”

4.2.2 Standard systems

The following settings are applicable to all standard systems:

Group type	Standard
Red/amber	1 s
Amber	4 s
Interval	6.0 s
Priority	No
Hold on red	No
Max. red	--s
Min. green	10 s
Min. red	1 s

4.2.2.1 One way

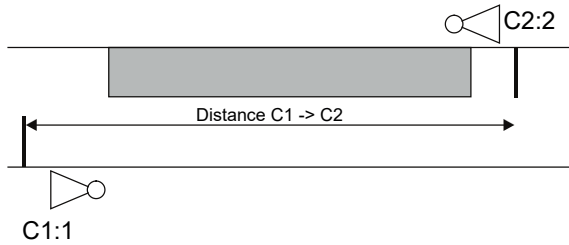

Signal time plan:

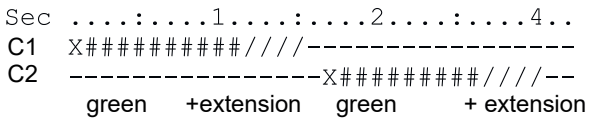

“X”=red/yellow “#”=green “/”=yellow “-”=red

4.2.2.2 Junction

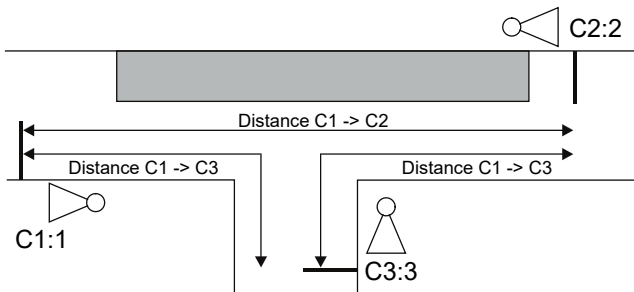

Signal time plan:



“X”=red/yellow “#”=green “/”=yellow “-”=red

4.2.2.3 Exit

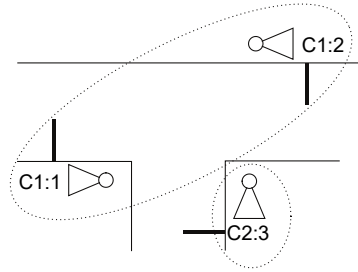

Signal time plan:

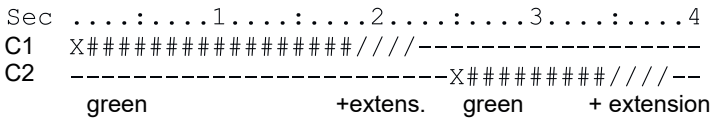

“X”=red/yellow “#”=green “/”=yellow “-”=red

4.2.2.4 4way 1lane

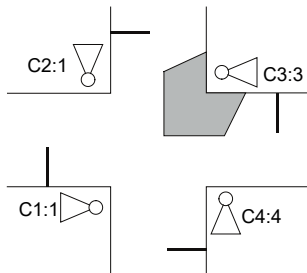

Signal time plan:

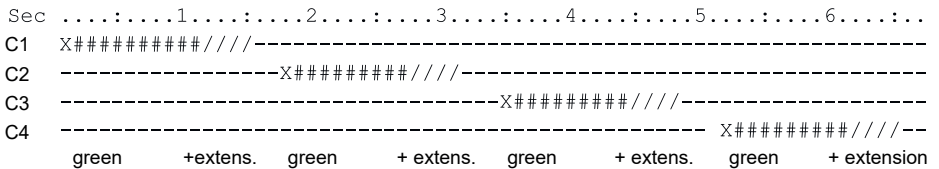

“X”=red/yellow “#”=green “/”=yellow “-”=red

4.2.2.5 2-way intersection

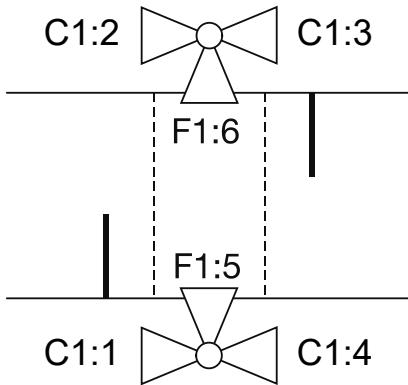

“Hold on red” is queried for C2 !!!

Signal time plan:

```

Sec . . . . . 1 . . . . . 2 . . . . . 3 . . .
C1  X#####////-----
C2  -----X#####////--
      green      +extens.  green      + extension
  
```

“X”=red/yellow “#”=green “/”=yellow “-”=red

4.2.3 Spezial

All program parameters listed under point 3.2.1 can be entered. This allows systems to be programmed that deviate from standard systems.

4.3. Programming intersection systems, INTERSECTION+

4.3.1 Functionality and parameters

The INTERSECTION+ point offers comprehensive programming options that approach the capabilities of modern permanent signalling systems.

In contrast to construction site signalling systems, the red and green times are not entered, but based on a cycle time to be set, it is determined at which second of the cycle a group is set to green and at which second green is deactivated again. Moreover, the complete intergreen period matrix is entered and monitored by the program.

INTERSECTION+ programs require greater programming effort, but offer far greater options for programming. In particular, the programs can also be synchronised with permanent systems.

The following parameters are available for programming:

Amount of groups 3

group 1	C1
Type:	Standard

Total number of groups used in the system (maximum 7).

Group type: The group type determines the signal sequence and the lamps used:

Standard (MOVH sec. dir.) (MOVH = motor vehicle): MOVH signal head having the signal sequence “red-red/amber-green-amber-red”.

In operating mode “flashing” it flashes amber.

(Main prim dir.) MOVH signal head having the signal sequence “red-red/amber-green-amber-red”.

In operating mode “flashing” it remains off.

Pedestrians: Signal head having the signal sequence “red-green-red”. When demanded, amber is switched on and can be used as “signal coming”.

Cars dark: MOVH signal head having the signal sequence “red-dark-amber-red”.

Ped. dark: Signal head having the signal sequence “dark-red-green-red-dark”.

MOVH flash.: MOVH signal head having the signal sequence “red-amber flashing amber-red”.

Clear. arrow: Signal head having the signal sequence “dark-green-dark”.

Flasher: Signal head having the signal sequence “dark-red flashing-dark”.

Flash. yel. 3: Signal head having the signal sequence “red-red/flashing-amber in the 3rd chamber amber-red”

Number of signal heads (traffic lights) that belong to the respective group. A maximum of 8 signal heads can be distributed among the individual groups.

group 1	C1
controllers	2

group 1	C1
Red / Yel.	1s

group 1	C1
Yellow	4s

group 1	C1
Priority:	No

group 1	C1
Rest Red:	No

group 1	C1
overjump	No

Red/amber – Time in seconds

Amber – Time in seconds

Upon “Yes”, the corresponding group receives a priority green signal when the sensor is triggered. This is done by suppressing all other sensor signals so that the associated groups are only assigned their minimum green time.

Upon “Yes”, the corresponding group is only assigned a green signal if a signal is received from the associated sensor.

The menu item only appears if “Hold on red Yes” was selected. If “Skip Yes” is selected and there is no signal from the sensor, the time of the group is skipped to the extent allowed by the signal timing plan. Upon “No” and a signal is not received from the sensor, the signal timing plan is processed unchanged, but the corresponding group is not activated.

group 1	C1
Program: 1	

Upon “Yes”, a sensor signal to this group triggers a switchover to the program specified in switchover time 1. The switchover takes place without observing the CST (common switchover time) at the fastest possible time if “Hold on red Yes” or “On-off Yes” was selected. Otherwise, the the switchover takes place at the CST. If a request no longer exists, the CST returns to the original program.

If switchover time 1 has already been assigned, the next switchover time is automatically used.

group 1	C1
Traffic gap:	

Interval for the traffic sensor in seconds

Intergreen	
C1 → P2	5s

Intergreen period of the “clearing” -> “entering” group. Upon “—” no intergreen period exists.

All possible combinations are queried in accordance with the number of groups.

Amount of Programs	
1	

Number of programs used (max. 5)

Program	
Fixed	

Program type

Possible values are:**fixed cycl., extendible Cycl., demand, special, extn. Fix, extn. extendible.**

For the type ‘demand’, the system waits for a sensor signal irrespective of the group specification. All groups of the type “Main” or - if not available

- all groups that are enabled in second 1 of the signal timing plan, show a green signal. For the types extn. Fixed and extn. extendible, all groups work only with green time extension and a fixed or extendible cycle, even if “Hold on red Yes” was selected.

Program 1	
Cycle	30 s

Cycle time of program1. The cycle time is quoted without extension times, as in the signal timing plan.

Program 1	
GPS:	1 s

Common switchover time (CST). The CST is used to switch between the programs. All programs must therefore display the same signal aspect in the CST. Moreover, synchronisation with the radio clock in the CST is delayed until synchronisation is achieved.

Program 1 on: 1 s	C1
----------------------	----

Program 1 off: 10 s	C1
------------------------	----

Program 1 Extension: 10 s	C1
------------------------------	----

Amount of switching times 1

Switch Time 1 Days: MTWTFSS Program: Program 1
--

or

Switch Time 1 C1 calls P2

Parameter Max. red: -- s

Parameter Min. green: 6 s

Parameter Min. red: 5 s

Synchronisation Procedure: Switchover Point offset: os
--

INTERSECTION + Spezial (Program name)
--

Enter the start ("From"), end ("To") and possible extension ("Ext.") of the green time for the respective group. The times can be read directly from the signal timing plan. The value for "To" can be smaller than the value for "From". For "-" there is no switch-on or switch-off time. The extension can be coupled to another group. The extension or demand will then only take place if the other group is extended and one of the sensors of the coupled groups is triggered. The group is displayed when the extension value is less than 0.

Enter the total number of existing switchover times (switchover points). At least one switchover time is required.

Switchover times. The weekdays on which the switchover time is valid, the time in hours:minutes and the program that is to be activated at this time are entered. In addition to entering the program number, "FI" (flashing) and "Off" (lamps off) are possible.

If the switchover is triggered by a sensor signal, only the program number is entered.

Maximum red time. Groups waiting in the "Hold on red" position are set to green once the maximum red time has expired, even if there is no sensor signal.

Night time dimming to ... % of maximum brightness
Minimum green time.

Minimum red time. Used when regressing into the same phase.

Recalculation method or recalculation time. Possible are:

- **Switchover point** (recalculation to the last switchover point)
- **01:01. - 00:00** (Siemens 2 recalculation to 1.1. of the Current year at 00:00)
- **01.01.80 00:00** (Siemens 3 recalculation to 1.1.1980 00:00)
- **Wait for pulse** (wait in the CST until a synchronous pulse arrives at the manual button input of control 1)
- **Synchronous pulse** (each synchronous pulse is selected as the recalculation time. If the offset is set to CST, the system can be synchronised with pulses that arrive at the CST. If the synchronous pulses fail, the system continues to run with the internal clock)

Overview of the program, program name and the number of program.

4.3.2 Examples

4.3.2.1 Pedestrian crossing with demand unit

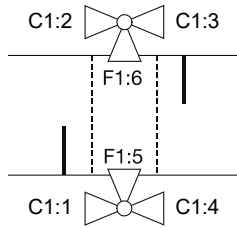

Signal timing plan:

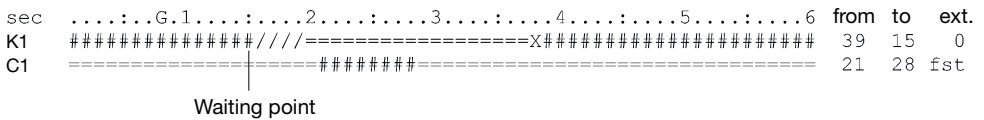

INTERSECTION+

Amount of groups 2

groups acc. to plan	EURO	Type	Amount controllers	red/yellows	yell. s	Prio.	Anf.	overjump No-Yes	Switch time	Traff.gaps
C1	C1	Kfz Nebenr	4	1	4	nein	nein	nein	nein	4,0
F1	C1	Fußgänger	2	0	0	nein	ja	nein	nein	4,0

Intergeen period matrix

	C1	F1				
C1		5				
F1	10					

Amount of switching times 1

	No	Mo	Tu	We	Th	Fr	Sa	Su	time	program
1	x	x	x	x	x	x	x	x		
2										

Programs _____

	Program1			Program2			Program3			Program 4			Program5		
Type	Dehnb.Uml														
Cycle/s	60														
GSP	8														
group	from	to	ext.	from	to	ext.	from	to	ext.	from	to	ext.	from	to	ext.
C1	39	15	0												
	21	28	fst												

Synchronisation Procedure _____

Max Red: s

Min. Green: s Min. Red: s

4.3.2.2 Bottleneck with pedestrian crossing

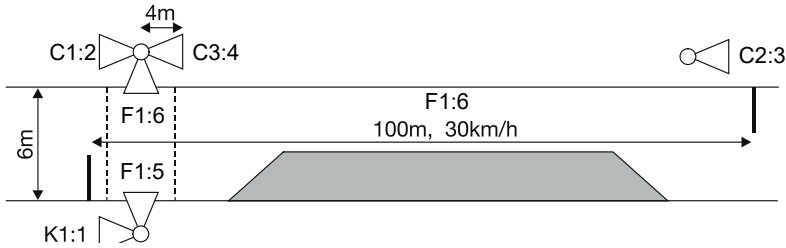

Signal timing plan without pedestrian request:

secG.1.....2.....3.....4.....	from	to	ext.
C1	X#####//==	2	11	30
C2	====X#####//==	26	35	30
C3E.....	10	--	fst
F1	====A=====	--	10	fst

Signal timing plan with pedestrian request:

secG.1.....2.....3.....4.....5	from	to	ext.
C1	X#####//==	2	11	30
C2	====X#####//==	28	37	30
C3//==	32	10	K1

INTERSECTION+

Amount of groups _____

groups acc. to plan	EURO	Type	Amount controllers	red/yellow s	yell. s	Prio.	Anf.	overjump No-Yes	Switch time	Traffic gaps
C1	C1	MOVH sec. dir.	2	1	4	no	no	no	no	5.0
C2	C2	MOVH sec. dir.	1	1	4	no	no	no	no	5.0
C3	C3	Cars dark	1	0	5	no	no	no	no	5.0
F1	F1	Pedestrians	2	0	0	no	no	no	yes	3.0

Intergeen period matrix

	C1	C2	C3	F1			
C1		14	--	5			
C2	14		--	--			
C3	--	--		5			
F1	6	--	6				

Amount of switching times _____

No	Mo	Tu	We	Th	Fr	Sa	Su	time	program
1								F1 demand	P2
2	x	x	x	x	x	x	x	00:00	P1
3									
4									
5									

Programs 4

	Program1			Program2			Program 3			Program 4			Program 5		
Type	extendible Cycle														
Cycle/s	48			50											
GSP	8			8											
group	from	to	ext.	from	to	ext.	from	to	ext.	from	to	ext.	from	to	ext.
C1	2	11	30	2	11	30									
C2	26	35	30	28	37	30									
C3	10	--	fst	32	10	C1									
C4	--	10	fst	17	26	fst									

4.3.3 Programming form

In order to maintain an overview of the myriad parameters that need to be set in KNOTEN+ programs, a programming form template (DIN A4) is enclosed with these operating instructions, which clearly sets out all of the possible input points. Such a form should always be completed before commencing programming.

4.4 Setting the time

The time is required for synchronising the quartz units and for synchronising multiple systems with each other. It is also needed for recording the internal operating log. It should therefore always be checked and, if necessary, set when setting a system up.

4.5 Extended program options

Under the “Set OPTIONS” menu item you will find various parameters for internationalising the programs together with some items that should only be changed in special cases:

Parameter	Default value	Meaning
Language	English	Terminal output language
Signal aspect	EN	Signal aspects arranged by country identifier. Changing this value sets all parameters to the country-specific default values. It also affects the calculation of red and green times.
Red man	Disabled	Upon “Yes”, the operator can switch a group to green in manual mode, even if the required intergreen period has not yet elapsed.
Timeout	5.0 s	Time period (0.5 ... 7.5 s) during which radio-linked systems continue to operate in the event of radio interference before they enter error mode. Cable-linked systems always operate with < 0.3 s timeout.
Quartz-sub.	Enabled	Radio-linked systems continue to operate in the so-called “quartz fall-back mode” if the radio connection fails; see point 3.3.3.
PTN	Disabled	Activates or locks the priority for public transport.
Green waiting	Disabled	If activated: The signal generator remains in green if there is no request from another signal generator or group.
Min. Dim:	50%	Maximum brightness of the LED fields in darkness. Between the minimum and maximum brightness, the adjustment takes place in steps. The switching point is between approx. 1400 lux (min.) and 3500 lux (max.).
Max. Dim:	100%	Maximum brightness of the LED fields in daylight

4.6 SVS radio remote switch

The radio remote switch can be used to manually control traffic. This is the case, for example, when construction vehicles are blocking the road or other activities are taking place in the traffic lane.

The system is available as an accessory and consists of a hand-held transmitter and receiver. The receiver is mounted on any signal head.

It contains a signal lamp that indicates the current operating status.

The radio remote switch allows all signal heads to be permanently switched to red when two groups are in operation.

Each group can additionally be switched to green. The signal heads remain in the respective phases as long as no other function is selected.

Manual mode can be exited at any time and the system then restarts the previously entered program. For a more detailed description, please refer to the operating instructions of the SVS radio remote switch. Accessories 26308 and 263091

IMPORTANT INFORMATION: The radar sensor on which the SVS receiver is mounted must be disconnected from the power supply. For information, see the SVS remote manual.

4.6.1 Operating terminal

Manual control is switched on via the operating terminal's operating mode menu. Now use the "R" key to move the cursor to a signal head in the group to be set to green. The "+" key switches the group to green and the "-" key switches the group back to red.

The cursor can also be moved to the next group while the previous group is still set to green. If the "+" key is now pressed, the selected group is set to green, taking the inter-green period into consideration. - See also point 3.5

5. Using the program memory

The program memory can be used to store several programs in the controller. In addition, each program is assigned a name which then appears on the status display (see point 3.1) when the respective program is running.

If required, stored programs can be transferred to another system at any time.

Press the "Menu" key until "Edit program" appears.

Pressing the "E" key takes you to the memory menu.

(The following illustration gives an example)

Name of the stored program

- | |
|---|
| <ul style="list-style-type: none">- Narrow point- Pilot- Exit |
|---|

Now press "+" or "-" to select your desired storage location and then press "E".

6. Status messages and error display

Errors that occur during operation are displayed on the operating terminal. The signal head in question is no longer displayed in a rectangle with a continuous line. The errors can be read out by pressing "R". All errors that have occurred appear here in plain text. Pressing the reset button resets the errors, if possible.

To read out errors from other signal heads, first select the signal head in question using the up or down arrow. The wide cursor beneath the display on the TFT's signal head screen selects the chosen signal head and pressing the "R" key opens the window to display the errors.

This function only works with cable- and radio-linked operation. Because signal heads are not connected together when operating in quartz mode, errors can only be displayed if the terminal is connected directly to the relevant signal head.

In the event of connection errors, all signal heads to which there is no connection appear as " _ " on the display.

In addition to radio interference or cable connection faults, connection errors may also be displayed if the power supply to a signal head fails.

7. Securing the signals

In radio- and cable-linked systems, errors or differences between the calculated and actual signal aspect (e.g. the intergreen period is too short) are immediately forwarded to all other signal heads and the entire system is switched to "flashing amber" mode if necessary.

The reaction time for cable-linked systems is < 0.3 s. For radio-linked systems, it depends on the number of signal heads and is between 0.5 s and 2.5 s.

If radio-linked systems suffer interference without a direct critical fault (e.g. failure of the red signal) being reported, the system is only switched to fault or quartz fall-back mode after the "Timeout" period set under the menu item "OPTIONS" (see points 2.3.3 and 3.5).

The signals between the signal heads are not secured in quartz systems. Gross deviations from the clock frequency can be detected by two independent time circuits. In this case, the relevant signal head switches to flashing amber, while all of the other signal heads continue to operate normally.

8. Red time counter (RTC)

Depending on the version, the signal head is supplied with or without a red time counter.

With Multi- and Euro-signal systems it is possible to retrofit a red time counter at any time.

The red time counter allows the remaining dwell time to be displayed.

After the program has started, the red time counter on Eurosignal systems needs around one cycle before the display activates and around three cycles for MultiSignal systems. If an error is detected, the red time counter switches the display to dark.

Since MultiSignal programs are normally vehicle-actuated, the red time is averaged and automatically adjusted by the red time counter in the event of a green time extension.

The red time counter has automatic brightness control. This can be deactivated if required. The display is at full brightness when dimming is deactivated.

DIP- switch - delivery status

DIP switch (table)	OFF	ON
Switch 1:	MultiSignal	EuroSignal
Switch 2:	no function	no function
Switch 3:	Dimmer on	Dimmer off
Switch 4:	RZZ on	RZZ off

Back side „Red time counter (RTC)”

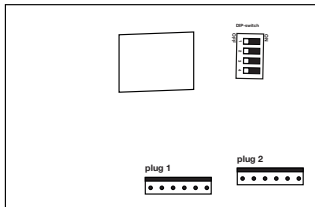

8.1 Cabling

Some of the cables in each signal head are already pre-installed at the factory.

In the upper half chamber there is a 6-pole plug with two wires. This is plugged onto connector 1 (towards the centre).

On plug 2 (towards the outside) is the power supply and the signals of individual LED fields.

The red chamber contains Wago terminals for the supply voltage.

Three further wires are connected to the LED fields. When retrofitting, the wire end ferrules must be removed beforehand, the wire stripped by about 10 mm and twisted with the accessory cable.

They must then be connected to the Wago terminal.

8.2 Terminal assignment

Note: The individual wires of connector 2 are connected to the same-coloured wires in the signal head via Wago terminals.

Connected via Wago terminals in the signal head.

Plug 1

Pin 5	brown
Pin 4	yellow/green

Plug 1

Pin 1	pink	+ LED field red
Pin 2	yellow	+ LED field amber
Pin 3	green	+ LED field green
Pin 4	white	Radar sensor only MS
Pin 5	black	Ground connection
Pin 6	red	Positive connection

9. Changing the battery and putting a system into operation

CAUTION!!

When changing the battery, ensure the battery trolley is sufficiently stable – there is a risk of it tipping over when empty!

RISK OF SHORT CIRCUIT !!

The signal head is supplied with a Rema plug system. To prevent short circuiting, first disconnect the Rema plug and then connect the terminals to the battery. Then reconnect the Rema plug to the traffic light system.

A dummy Rema plug is supplied with each signal head. Always connect this to the second Rema plug that is not in use.

9.1 Changing the battery

Changing the battery without interrupting the program that is running using the optional Rema connector (accessory).

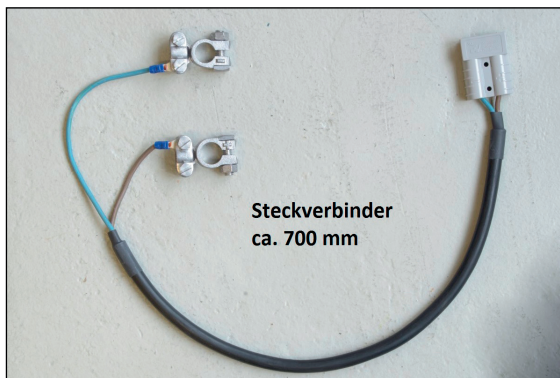

Rema connector



1. Connect the optional Rema connector to the charged battery.
2. Disconnect the dummy plug from the second Rema connector on the discharged battery and connect it to the second battery.
3. Disconnect the Rema connector from discharged battery and place the dummy connector on the open Rema connector.
4. Disconnect the terminals from the discharged battery and remove the battery from the battery trolley.
5. Place the charged battery into the battery trolley.

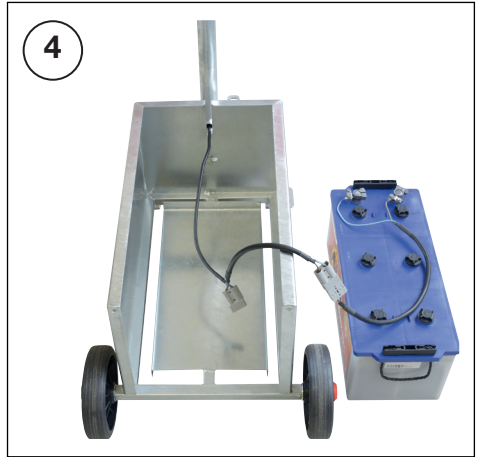
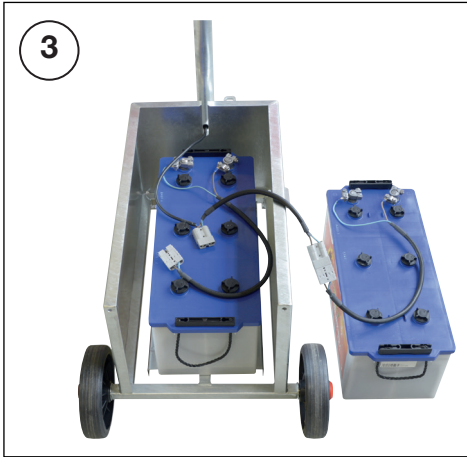
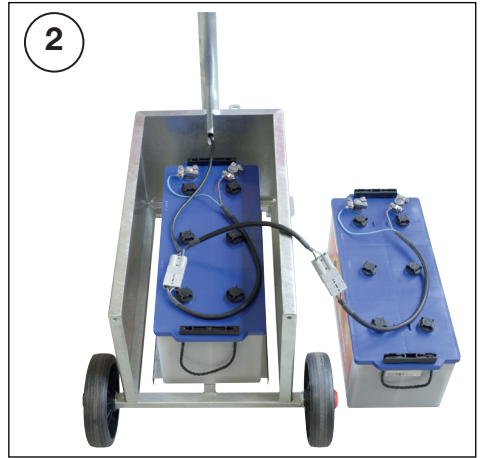
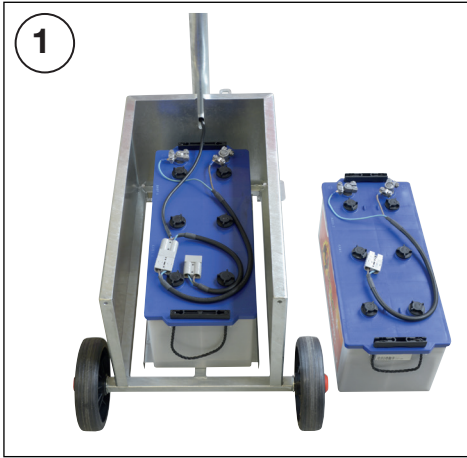

9.2 Fuse

The system is also fitted with a fuse to prevent malfunctions. It is fitted inside the green chamber.

If the system no longer functions, check the fuse and replace it with a standard 5 A automotive fuse if necessary.

10. Technical parameters

Operating voltage.....	11 - 15 V DC
Av. power consumption – radio operation.....	8 W
Av. power consumption – cable/quartz operation.....	7 W
Operating temperature range.....	-20°C - +55°C
Time setting range.....	0 s - 999 s
Lamp	12 V / 4W LED
Radio range	approx. 1,000 m (depending on location)

Subject to technical alterations

10.1 Classifications

Power class:	A2/2
Luminous intensity distribution:	W
Phantomklasse:	5
Phantom class:	S1
Impact resistance:	Class IR3, Class IR2, Class IR1
Protection class: IP55	IP54
Environmental class:	Class A, Class B, Class C



Radio data modem WZ FSE 2-2 FFSK

Country	Channel	Germany	Austria	Switzerland
Frequencies	Auto	automatic	automatic	automatic
	1	151.09 MHz	151,050 MHz ¹⁾	173,25 MHz
	2	170.63 MHz	151,075 MHz ¹⁾	173,275 MHz
	3	170.75 MHz	151,150 MHz	173,35 MHz
	4	170.77 MHz		
	5	161.11 MHz		
	6	161.27 MHz		
Transmission power		100 mW	100 mW ²⁾	100 mW ²⁾
Operating mode		Semi-Duplex	Semi-Duplex	Semi-Duplex
Bandwidth		14 kHz	14 kHz	14 kHz
Channel spacing		20 kHz	25 kHz	25 kHz
Transmission type		F3E	F3E	F3E
Occupancy time		uninterrupted	uninterrupted	uninterrupted

¹⁾ Not allocable in Vorarlberg and BH Landeck

²⁾ 500 mW on request

11. Spare parts overview

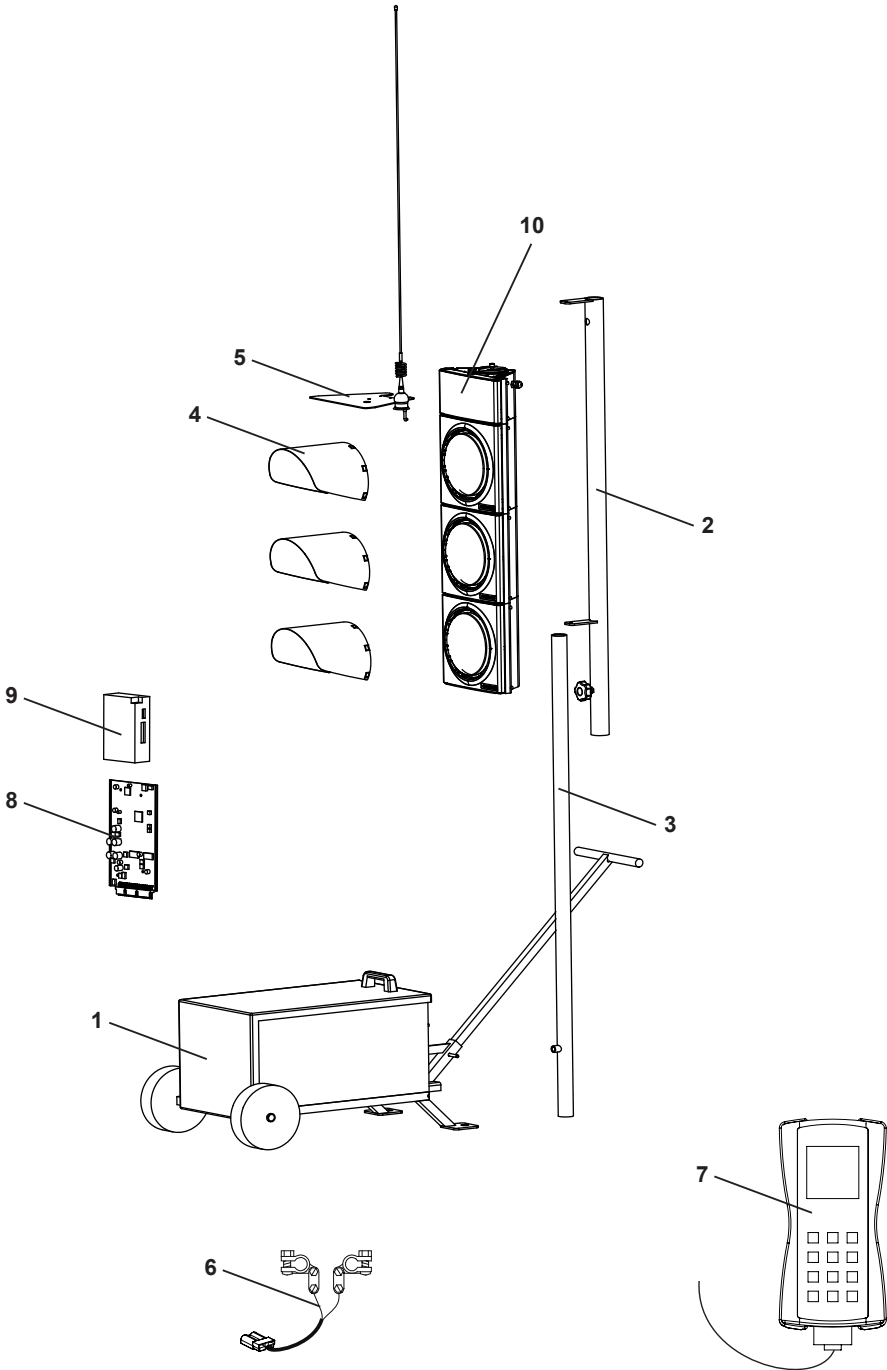

Item	Name	
1	Battery trolley.....	26204ROT
2	Signal post, upper	>
3	Signal post, lower	
4	Hood	93991
5	Antenna set (pre-mounted on antenna plate).....	on request
6	Rema plug/connector	82243
7	Microterminal control unit	26315
8	Controller	on request
9	Radio modem	on request
10	Red-time counter	on request

Contact number

Multi-Signal Service Hotline 0151-17419286

12. Accessories

SVS - Radio remote switch, transmitter26308

SVS - Radio remote switch, receiver....263091

